

Data Sheet



Article number: 204050M10100A3S

Description: E+G levelling foot
GN 40-50-M10-100-A3-S

Note: S Without nut, External hexagon at the bottom

Measures

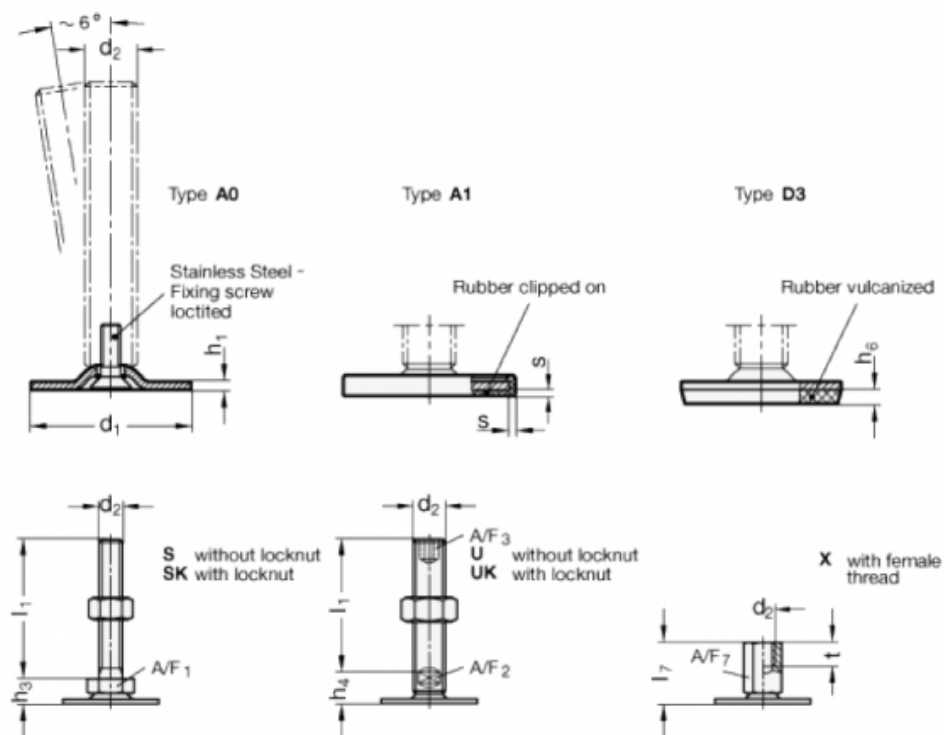

A/F1	=	17
d1	=	50
d2	=	M10
h1	=	2.5
h3	=	11
h6	=	4
l1	=	100
s	=	